

TASCAM

TEAC Professional Division

3D0024910A

MD-301MKII

MINIDISC DECK

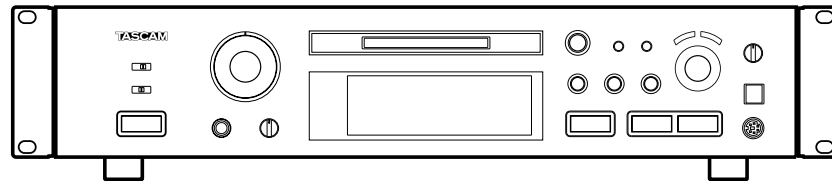

OWNER'S MANUAL / MANUEL DU PROPRIETAIRE
BEDIENUNGSANLEITUNG / MANUALE DI ISTRUZIONI
MANUAL DEL USUARIO / GEBRUIKSAANWIJZING



CAUTION
RISK OF ELECTRIC SHOCK
DO NOT OPEN



CAUTION: TO REDUCE THE RISK OF ELECTRIC SHOCK, DO NOT REMOVE COVER (OR BACK). NO USER-SERVICEABLE PARTS INSIDE. REFER SERVICING TO QUALIFIED SERVICE PERSONNEL.



The lightning flash with arrowhead symbol, within an equilateral triangle, is intended to alert the user to the presence of uninsulated "dangerous voltage" within the product's enclosure that may be of sufficient magnitude to constitute a risk of electric shock to persons.



The exclamation point within an equilateral triangle is intended to alert the user to the presence of important operating and maintenance (servicing) instructions in the literature accompanying the appliance.

This appliance has a serial number located on the rear panel. Please record the model number and serial number and retain them for your records.

Model number _____
Serial number _____

WARNING: TO PREVENT FIRE OR SHOCK HAZARD, DO NOT EXPOSE THIS APPLIANCE TO RAIN OR MOISTURE.

ENGLISH

FRANÇAIS

DEUTSCH

ITALIANO

ESPAÑOL

IMPORTANT SAFETY INSTRUCTIONS

CAUTION:

- Read all of these Instructions.
- Save these Instructions for later use.
- Follow all Warnings and Instructions marked on the audio equipment.

- 1) Read Instructions** — All the safety and operating instructions should be read before the product is operated.
- 2) Retain Instructions** — The safety and operating instructions should be retained for future reference.
- 3) Heed Warnings** — All warnings on the product and in the operating instructions should be adhered to.
- 4) Follow Instructions** — All operating and use instructions should be followed.
- 5) Cleaning** — Unplug this product from the wall outlet before cleaning. Do not use liquid cleaners or aerosol cleaners. Use a damp cloth for cleaning.
- 6) Attachments** — Do not use attachments not recommended by the product manufacturer as they may cause hazards.
- 7) Water and Moisture** — Do not use this product near water — for example, near a bath tub, wash bowl, kitchen sink, or laundry tub; in a wet basement; or near a swimming pool; and the like.
- 8) Accessories** — Do not place this product on an unstable cart, stand, tripod, bracket, or table. The product may fall, causing serious injury to a child or adult, and serious damage to the product. Use only with a cart, stand, tripod, bracket, or table recommended by the manufacturer, or sold with the product. Any mounting of the product should follow the manufacturer's instructions, and should use a mounting accessory recommended by the manufacturer.
- 9) A product and cart combination should be moved with care.** Quick stops, excessive force, and uneven surfaces may cause the product and cart combination to overturn.



- 10) Ventilation** — Slots and openings in the cabinet are provided for ventilation and to ensure reliable operation of the product and to protect it from overheating, and these openings must not be blocked or covered. The openings should never be blocked by placing the product on a bed, sofa, rug, or other similar surface. This product should not be placed in a built-in installation such as a bookcase or rack unless proper ventilation is provided or the manufacturer's instructions have been adhered to.
- 11) Power Sources** — This product should be operated only from the type of power source indicated on the marking label. If you are not sure of the type of power supply to your home, consult your product dealer or local power company. For products intended to operate from battery power, or other sources, refer to the operating instructions.
- 12) Grounding or Polarization** — This product may be equipped with a polarized alternating-current line plug (a plug having one blade wider than the other). This plug will fit into the power outlet only one way. This is a safety feature. If you are unable to insert the plug fully into the outlet, try reversing the plug. If the plug should still fail to fit, contact your electrician to replace your obsolete outlet. Do not defeat the safety purpose of the polarized plug.
- 13) Power-Cord Protection** — Power-supply cords should be routed so that they are not likely to be walked on or pinched by items placed upon or against them, paying particular attention to cords at plugs, convenience receptacles, and the point where they exit from the product.
- 14) Outdoor Antenna Grounding** — If an outside antenna or cable system is connected to the product, be sure the antenna or cable system is grounded so as to provide some protection against voltage surges and built-up static charges. Article 810 of the National Electrical Code, ANSI/NFPA 70, provides information with regard to proper grounding of the mast and supporting structure, grounding of the lead-in wire to an antenna discharge unit, size of grounding conductors, location of antenna-discharge unit, connection to grounding electrodes, and requirements for the grounding electrode.
"Note to CATV system installer:
This reminder is provided to call the CATV system installer's attention to Section 820-40 of the NEC which provides guidelines for proper

grounding and, in particular, specifies that the cable ground shall be connected to the grounding system of the building, as close to the point of cable entry as practical.

Example of Antenna Grounding as per National Electrical Code, ANSI/NFPA 70

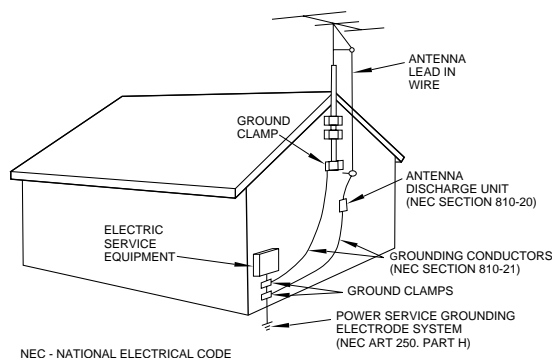

- 15) Lightning** — For added protection for this product during a lightning storm, or when it is left unattended and unused for long periods of time, unplug it from the wall outlet and disconnect the antenna or cable system. This will prevent damage to the product due to lightning and power-line surges.
- 16) Power Lines** — An outside antenna system should not be located in the vicinity of overhead power lines or other electric light or power circuits, or where it can fall into such power lines or circuits. When installing an outside antenna system, extreme care should be taken to keep from touching such power lines or circuits as contact with them might be fatal.
- 17) Overloading** — Do not overload wall outlets, extension cords, or integral convenience receptacles as this can result in risk of fire or electric shock.
- 18) Object and Liquid Entry** — Never push objects of any kind into this product through openings as they may touch dangerous voltage points or short-out parts that could result in a fire or electric shock. Never spill liquid of any kind on the product.
- 19) Servicing** — Do not attempt to service this product yourself as opening or removing covers may expose you to dangerous voltage or other hazards. Refer all servicing to qualified service personnel.
- 20) Damage Requiring Service** — Unplug this product from the wall outlet and refer servicing to qualified service personnel under the following conditions:
 - a) when the power-supply cord or plug is damaged.
 - b) if liquid has been spilled, or objects have fallen into the product.
 - c) if the product has been exposed to rain or water.
 - d) if the product does not operate normally by following the operating instructions. Adjust only those controls that are covered by the operating instructions as an improper adjustment of other controls may result in damage and will often require extensive work by a qualified technician to restore the product to its normal operation.
 - e) if the product has been dropped or damaged in any way.
 - f) when the product exhibits a distinct change in performance — this indicates a need for service.
- 21) Replacement Parts** — When replacement parts are required, be sure the service technician has used replacement parts specified by the manufacturer or have the same characteristics as the original part. Unauthorized substitutions may result in fire, electric shock, or other hazards.
- 22) Safety Check** — Upon completion of any service or repairs to this product, ask the service technician to perform safety checks to determine that the product is in proper operating condition.
- 23) Wall or Ceiling Mounting** — The product should be mounted to a wall or ceiling only as recommended by the manufacturer.
- 24) Heat** — The product should be situated away from heat sources such as radiators, heat registers, stoves, or other products (including amplifiers) that produce heat.

SAFETY INFORMATION

This product has been designed and manufactured according to FDA regulations "title 21, CFR, chapter 1, subchapter J, based on the Radiation Control for Health and Safety Act of 1968", and is classified as class 1 laser product. There is no hazardous invisible laser radiation during operation because invisible laser radiation emitted inside of this product is completely confined in the protective housings.

The label required in this regulation is shown ①.

● CAUTION

- DO NOT REMOVE THE PROTECTIVE HOUSING USING SCREWDRIVER.
- USE OF CONTROLS OR ADJUSTMENTS OR PERFORMANCE OF PROCEDURES OTHER THAN THOSE SPECIFIED HEREIN MAY RESULT IN HAZARDOUS RADIATION EXPOSURE.
- IF THIS PRODUCT DEVELOPS TROUBLE, MAKE A CONTACT WITH OUR SERVICEMAN, AND DO NOT USE THE PRODUCT IN A TROUBLED STATE.

Optical pickup: Type : KMS-260A
 Manufacturer : SONY Corporation
 Laser output : 4.55 mW
 Wavelength : 785 ± 20 nm

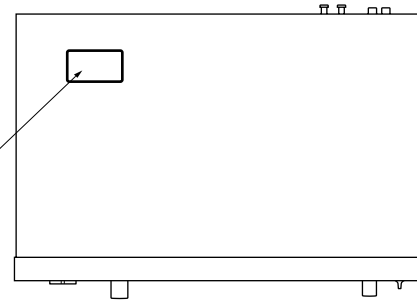

For U.S.A.
 ① **CERTIFICATION**
 THIS PRODUCT COMPLES WITH DHHS
 RULES 21 CFR SUBCHAPTER J APPLI-
 CABLE AT DATE OF MANUFACTURE
 TEAC CORPORATION
 37-3 NAKA-CHO, MUSASHINO-SHI, TOKYO, JAPAN
 MANUFACTURED TIF

● CAUTION ● ACHTUNG ● OBSERVERA ● ADVARSEL

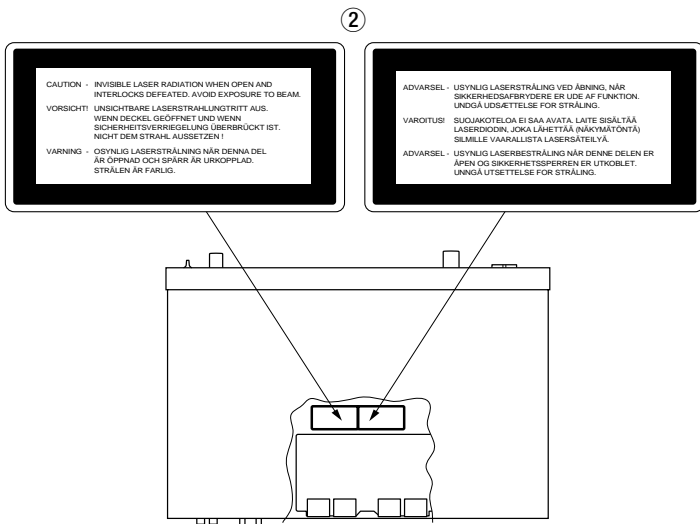

① THIS LABEL IS ATTACHED TO THE PLACE AS ILLUSTRATED TO INFORM THAT THE APPARATUS CONTAINS A LASER COMPONENT.

① DIESE AUFKLEBEMARKE IST AN DEM IN DER ABBILDUNG GEZEIGTEN ORT ANBRACHT UM DARAUF HINZUWEISEN, DASS IM INNERN DES GERÄTS EINE LASER-KOMPONENTE BEFINDET.

① PÅSKRIFTEN SITTER PÅ APPARATEN SOM VISAS SOM UPPMANING OM ATT APPARATEN OMFATTAR EN INBYGGD LASERKOMPONENT.

① DETTE MÆRKAT ER ANBRAGT SOM VIST I ILLUSTRATIONEN FOR AT ADVARE BRUGEREN OM AT APPARATET INDEHOLDER EN LASERKOMPONENT.

② DETTE MÆRKAT ER SOM VIST PÅ ILLUSTRATIONEN ANBRAGT PÅ INDERSIDEN AF TOPDÆKSLET FOR AT ADVARE BRUGEREN OM AT YDERLIGERE FREMTRÆNGEN VIL VÆRE FORBUNDET MED FARE FOR AT UDSÆTTE SIG FOR LASERSTRÅLING.

ADVARSEL — BETJENING AF ANDRE KONTROLLER OG REGULATORER ELLER BENYTTES AF ANDRE FREMGANGSMÅDER END BESKREVET HERI ER FOR-BUNDET MED FARE FOR UDSÆTTELSE FOR LASERSTRÅLING.

VARNING: APPARATEN INNEHÅLLER LASER KOMPONENT MED STRÅLNING ÖVERSTIGANDE KLASS 1.

"ADVARSEL: USYNLIG LASERSTRÅLING VED ÅBNING NAR SIKKERHEDSafbrydere er ude af funktion. UNDGÅ UDSÆTTELSE FOR STRÅLING"

"VAROITUS! SUOJAKOTELOA EI SAA AVATA. LAITE SISÄLTÄÄ LASERDIODIN. JOKA LÄHETTÄ (NÄKYMÄTÖNTÄ) SILMILLE VAARALLISTA LASERSÄTEILYÄ".

ADVARSEL: USYNLIG LASERBESTRÅLING NÅR DENNE DELEN ER ÅPEN OG SIKKERHETSSPERREN ER UTKOBLET UNNGÅ UTSETTELSE FOR STRÅLING.

① **CLASS 1 LASER PRODUCT**
LUOKAN 1 LASERLAITE
KLASS 1 LASERAPPARAT

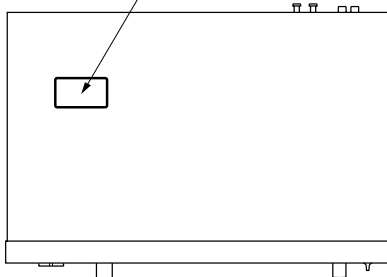

Contents

IMPORTANT SAFETY INSTRUCTIONS	2-3
Before Use	4
Read This Before Operating	4
Handling MDs	5
Memory back-up function	5
When "Protected !!" is displayed.....	5
While "UTOC Writing" is blinking.....	5
When "D-IN UNLOCK !" blinks.....	5
Remote Control Unit.....	5
Rack Mounting.....	6
Voltage Conversion (For general export models).....	6
Connections	6
Connection	6
Name of Each Control	7
Recording	8
Recording an MD	8
Notes on Recording	8
Playback	9
Normal Playback	9
Useful Tips for Recording	10
Monitoring the Input Signal	10
Adjusting the Recording Level	10
Assigning Track Numbers During Recording	10
Recording Over Existing Tracks (Over Write)	10
Sync Recording	11
Checking the Remaining MD Recording Time	11
Checking the Recorded Tracks	11
Timer Recording	11
Useful Tips for Playback	12
Using the Display Window	12
Selecting the Desired Track	12
Playing Tracks in Random Order (Shuffle Playback)	12
When Recording to Analog Tape	13
Playing Tracks in the Desired Order (Program Playback)	13
Repeating Track(s) (Repeat Playback)	14
Timer Playback	14
Editing Recorded MDs	15
Notes on Editing	15
Erasing Track(s) (ERASE Function)	15
Dividing a Track (DIVIDE Function)	16
Combining Tracks (COMBINE Function)	16
Moving a Track (MOVE Function)	16
Assigning Titles (TITLE Function)	17
Assigning Titles to the Disc and All Tracks Successively (TITLE AUTO INC Function).....	17-18
Changing entered characters.....	18
Copying a Title (TITLE COPY Function).....	18
Canceling the Last Operation (UNDO Function)	18
Optional Functions	19
Correspondence between deck buttons and keyboard keys.....	19
Editing keys	19
Title entry keys	19
System Restrictions	19-20
Display Messages	20
Guide to the Serial Copy Management System	21
Serial Copy Management System	21
Troubleshooting	22
Specifications	22

Before Use

Read This Before Operating

- Place the unit on a hard flat surface.
- Avoid placing it in direct sunlight or close to a source of heat. Also avoid locations subject to vibrations and excessive dust, heat, cold or moisture.
- Do not open the cabinet, as this might result in circuitry damage or electrical shock.
- Do not attempt to clean the unit with chemical solvents, as this might damage the finish. Use a clean, dry cloth.
- When removing the power plug from the wall outlet, always pull directly on the plug, never yank the cord.
- Keep this manual in a safe place for future reference.

IMPORTANT (for U.K. Customers)

DO NOT cut off the mains plug from this equipment. If the plug fitted is not suitable for the power points in your home or the cable is too short to reach a power point, then obtain an appropriate safety approved extension lead or consult your dealer.

If nonetheless the mains plug is cut off, remove the fuse and dispose of the plug immediately, to avoid a possible shock hazard by inadvertent connection to the mains supply.

If this product is not provided with a mains plug, or one has to be fitted, then follow the instructions given below:

IMPORTANT. DO NOT make any connection to the larger terminal which is marked with the letter E or by the safety earth symbol \perp or coloured GREEN or GREEN-and-YELLOW.

The wires in the mains lead on this product are coloured in accordance with the following code:

BLUE: NEUTRAL
BROWN: LIVE

As these colours may not correspond with the coloured markings identifying the terminals in your plug proceed as follows:

The wire which is coloured BLUE must be connected to the terminal which is marked with the letter N or coloured BLACK.

The wire which is coloured BROWN must be connected to the terminal which is marked with the letter L or coloured RED.

When replacing the fuse only a correctly rated approved type should be used and be sure to re-fit the fuse cover.
IF IN DOUBT — CONSULT A COMPETENT ELECTRICIAN.

■ Handling MDs

The MiniDisc (MD) measures 64 mm in diameter. Although the MD is housed in a protective cartridge (68 mm x 72 mm x 5 mm) and can be handled easily, deck malfunctions may result if the cartridge gets dust on it or is damaged. To protect the disc, always take the following precautions:

- Be sure that the MD is taken out of the deck and put back in its MD case after using it.
- Do not touch the disc inside the cartridge. Do not open the shutter to expose the MD.
- Do not place MDs in direct sunlight, high temperatures, or high levels of humidity.
- Use a dry, soft cloth to clean the cartridge.
- When attaching a label to the MD cartridge, be sure to apply it correctly to the specified position. If the label is rolled up or partially detached, the MD cartridge may get stuck inside the deck.
- Do not place one label on top of another.

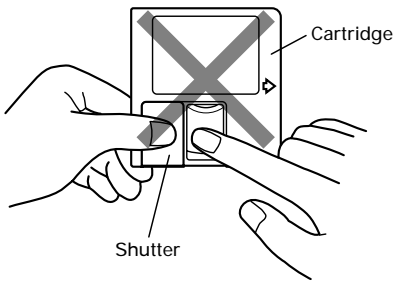

■ Memory back-up function

This unit is provided with a memory back-up function. When you use the deck for the first time, leave it on for about 5 minutes to allow the back-up circuit to be charged and become operational. When not using the deck for a while, try to turn the power on every 3 or 4 days.

■ Serial Copy Management System

This deck complies with the SCMS (Serial Copy Management System). As a result, it is not possible to digitally record from a source MD which has been recorded digitally.

■ When "Protected !!!" is displayed

- A playback-only MD is loaded.
- The MD is record-protected against accidental erasure. To make recording (or editing) possible, slide the record-protect tab to close the hole.

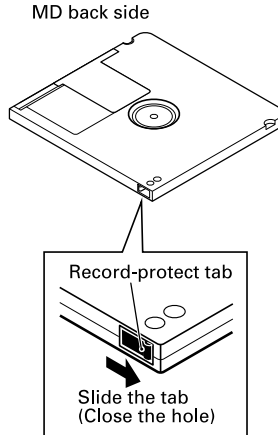

■ While "UTOC Writing" is blinking:

"UTOC Writing" blinks while the MD is being ejected after recording (or editing). While it is blinking, the recorded data is being written on the MD. Do not pull out the power cord or vibrate the deck. Otherwise the recorded data may not be written correctly on the MD.

If the power is turned off with the MD left in the deck ("TOC EDIT" lights up) after recording, the UTOC cannot be recorded. Turn the power back on within 3 or 4 days and eject the MD. The recorded data might be lost if the MD is left in the deck for a long time.

■ When "D-IN UNLOCK !" blinks

- The program source is not connected to the [DIGITAL INPUT 1] or [DIGITAL IN 2] terminal even though you have selected [DIGITAL 1] or [DIGITAL 2] with the [INPUT SELECTOR]. Either make the digital connection or select [ANALOG] with the [INPUT SELECTOR] and perform analog recording.
- This message also appears when the digital signal input is interrupted during digital recording. To continue recording, restart the digital program source.

Remote Control Unit

When operating the remote control unit, point it towards the remote sensor on the front panel of the unit.

■ Battery installation

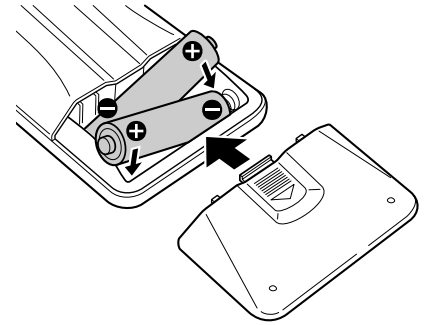

1. Remove the battery compartment cover.

2. Insert two "AA" (R6, SUM-3) dry batteries.

Make sure that the batteries are inserted with their positive ⊕ and negative ⊖ poles positioned correctly.

3. Close the cover until it clicks.

Battery replacement

If you notice that the distance between the remote control unit and the player for correct operation becomes shorter, it indicates that the batteries are exhausted. In this case replace the batteries with new ones.

Precautions concerning batteries

- Be sure to insert the batteries with correct positive ⊕ and negative ⊖ polarities.
- Use batteries of the same type. Never use different types of batteries together.
- Rechargeable and non-rechargeable batteries can be used. Refer to the precautions on their labels.
- When the remote control unit is not to be used for a long time (more than a month), remove the batteries from the remote control unit to prevent them from leaking. If they leak, wipe away the liquid inside the battery compartment and replace the batteries with new ones.
- Do not heat or disassemble batteries and never dispose of old batteries by throwing them in fire.

Rack Mounting

Install this deck with the provided mounting screw kit as illustrated.

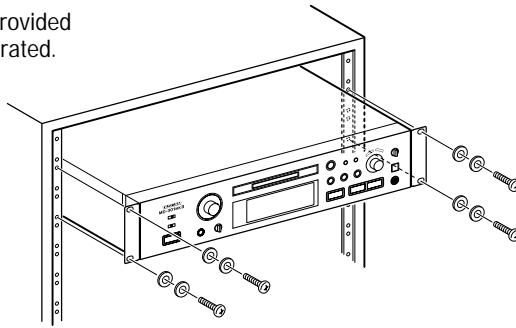

Voltage Conversion (For general export models)

Be sure to remove the power cord from the AC outlet before repositioning the voltage converter switch.

1. Locate the voltage selector on the rear panel.
2. Using a flat-bladed screwdriver, set to the appropriate 230 V or 120 V position according to your area.

IN NORTH AMERICA
USE ONLY ON 120 V
SUPPLY.

DANS L'AMERIQUE
DU NORD:
UTILISABLE SUR 120 V
D'ALIMENTATION
UNIQUEMENT.

Connections

- Turn off power for all equipment before making connections.
- Read instructions of each component you intend to use with the MD deck.

■ Connection

ANALOG INPUT/OUTPUT (BALANCED/UNBALANCED) terminals

Use these terminals to connect the deck to a mixer, cassette tape recorder or other components.

- Be sure to insert each plug securely. To prevent hum and noise, do not bundle the connection cords with the power cord or speaker cord.

DIGITAL INPUT 1/OUTPUT terminals

Use these terminals to connect the deck to a digital component (such as a CD player, DAT deck, digital amplifier, or another MD deck).

- Use a digital optical (TOS) cable (optional) for digital recording. Connect the [DIGITAL IN 2] terminal located on the front panel to a digital component such as a DAT/MD deck.
- When making a digital connection, remove the caps from the terminals. When the terminals are not in use, leave the caps in place.

■ Power cord

Be sure to connect the power cord to an AC outlet which supplies the correct voltage.

- Hold the power plug when plugging or unplugging the power cord.

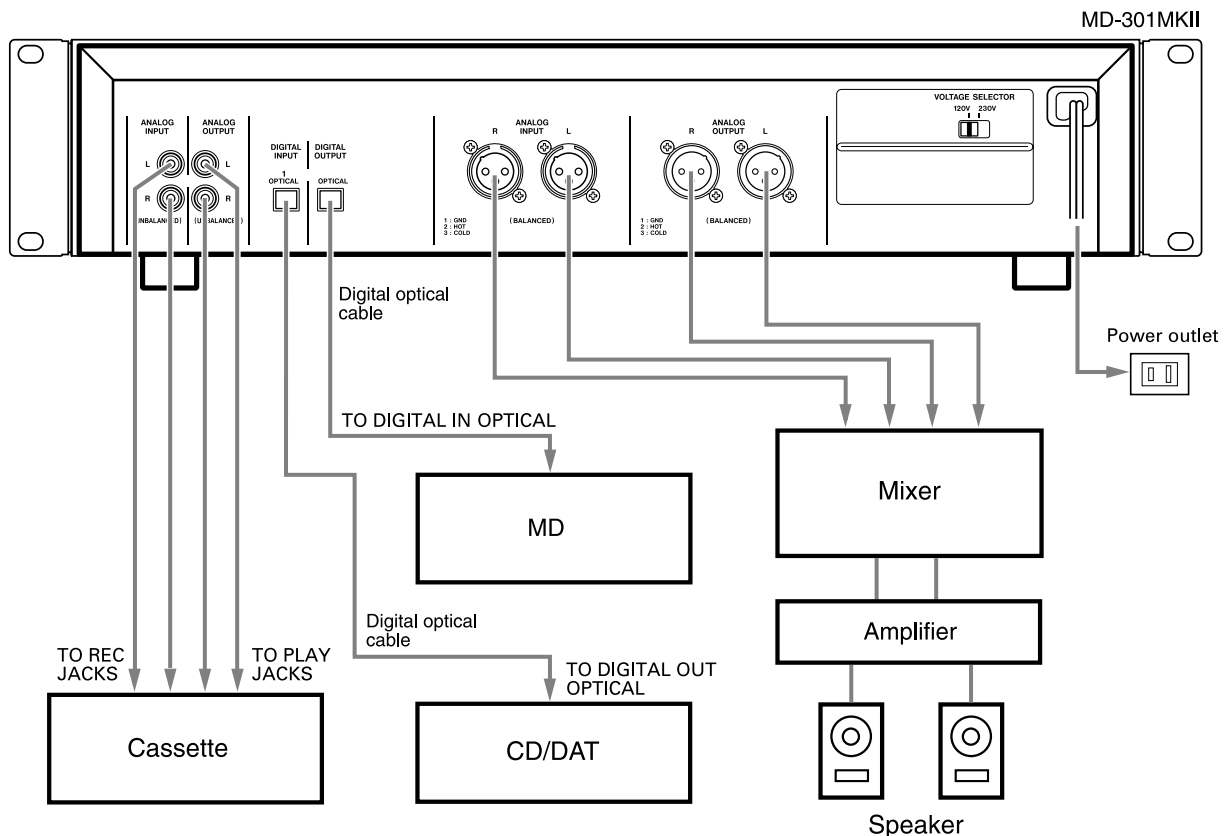

Name of Each Control

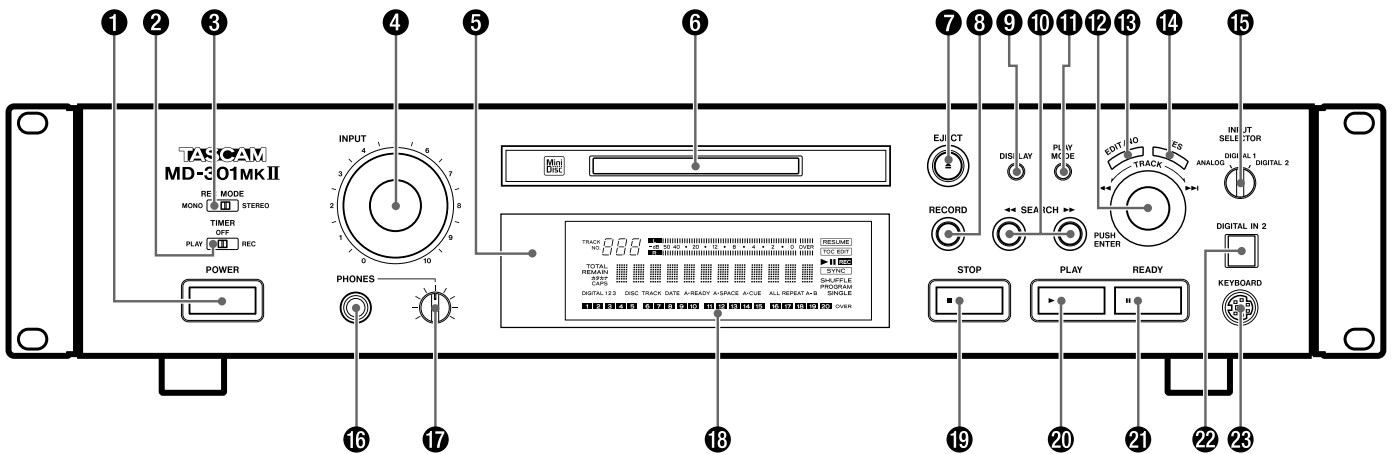

- ❶ [POWER] button
- ❷ [TIMER PLAY/OFF/REC] switch
- ❸ [REC MODE MONO/STEREO] switch
- ❹ [INPUT] control
- ❺ Remote sensor
- ❻ Disc insertion slot
- ❼ [▲ EJECT] button
- ❽ [● RECORD] button
- ❾ [DISPLAY] button
- ❿ [◀◀ SEARCH ▶▶] buttons
- ⓫ [PLAY MODE] button
- ⓬ [◀◀ TRACK ▶▶] dial / [PUSH ENTER]
- ⓭ [EDIT/NO] button
- ⓮ [YES] button
- ⓯ [INPUT SELECTOR] switch
- ⓰ [PHONES] jack
- ⓱ PHONES level control
- ⓲ Display window
- ⓳ [■ STOP] button
- ⓴ [▶ PLAY] button
- ⓵ [▬ READY] button
- ⓶ [DIGITAL IN 2] terminal
- ⓷ [KEYBOARD] terminal

- ⓸ [AUTO SPACE] button
- ⓹ [SCROLL] button
- ⓺ Character select button [CHAR SELECT]
- ⓻ [ENTER] button
- ⓼ [◀◀ TRACK ▶▶] buttons

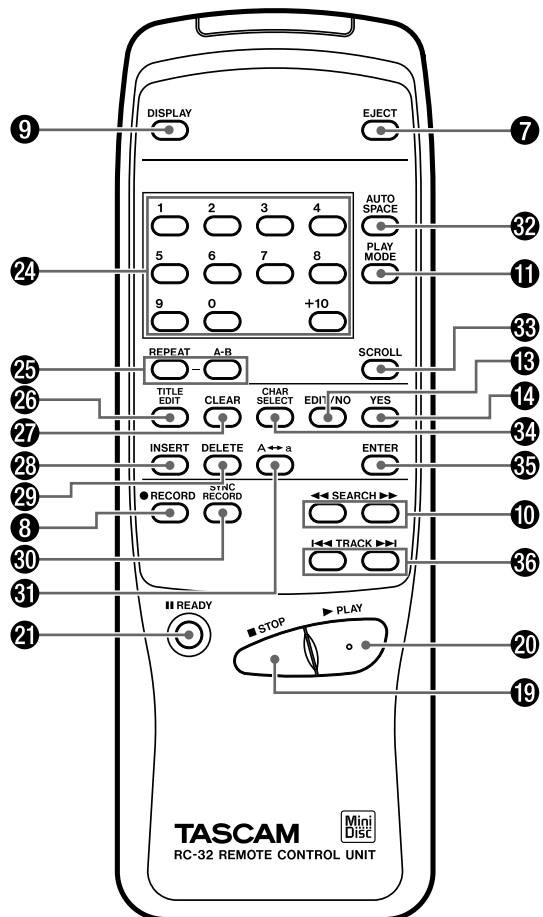

Recording

Buttons used on this page

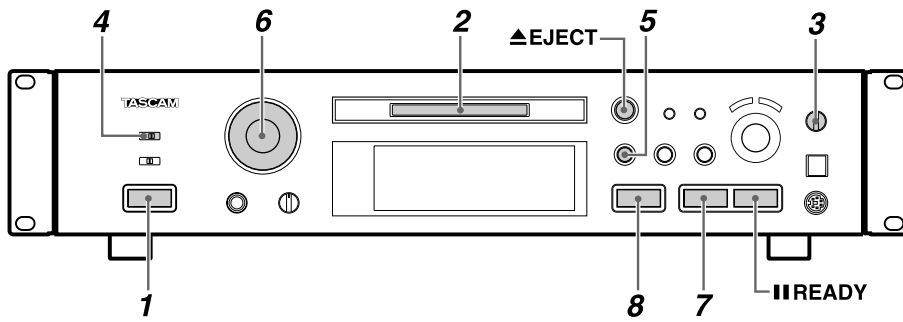

Recording an MD

1. Press the [POWER] button.
 - "NO DISC" appears on the display.
 - Turn on the source component and the amplifier. Set the input selector to the source component.
2. Insert a recordable MD.

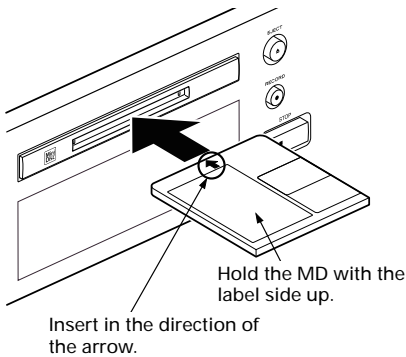

- When a blank MD is inserted, the display shows "Disc Loading", "TOC Reading", "No Track !!" and "Blank Disc" in sequence.
 - When a partially recorded MD is inserted, the deck will automatically start recording from the end of the last recorded track.
3. Select the input with the [INPUT SELECTOR].

Display	Selected Input
ANALOG	ANALOG INPUT
DIGITAL 1	DIGITAL INPUT 1 (OPTICAL)
DIGITAL 2	DIGITAL IN 2 (OPTICAL) (front panel)

4. Select the recording mode with the [REC MODE] switch.
 - When [STEREO] is selected, stereo recording will be performed.
 - When [MONO] is selected, monaural recording will be performed using only the left (L) channel. "L" appears on the level meter, but the output is sent to both channels.

- The maximum amount of time available with monaural recording is twice that of stereo recording.
5. Press the [RECORD] button.
 - The deck enters the Record-Ready mode ("|| REC " lights up).
 - "Disc Full !!" or "Track Full !!" is displayed when no room is available on the MD for recording.
 6. Adjust the recording level.
 - If [ANALOG] was selected above, adjust the recording level with the [INPUT] control.
 - When adjusting the recording level, adjust so that the "OVER" segments of the peak level meter do not light up.
 7. Start recording. Press the [PLAY] button or the [READY] button ("|| REC " lights up). Start playing the source program.
 8. To stop recording, press the [STOP] button.

- **To stop recording temporarily (ready)**
Press the [READY] button.
 - Press the [PLAY] or [READY] button to resume recording.
 - Whenever you pause recording, the track number increases by one.

- **To eject the MD**
Press the [EJECT] button.

If the power is turned off with the MD left in the deck ("TOC EDIT" lights up) after recording, the UTOC cannot be recorded. Turn the power back on within 3 or 4 days and eject the MD. The recorded data might be lost if the MD is left in the deck for a long time.

Notes on Recording

■ To protect an MD against accidental erasure

- After recording an MD, slide the record-protect tab to open the hole.
- To record on the MD again, slide the tab to close the hole.

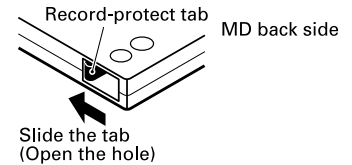

■ When "Disc Full !!" or "Track Full !!" is displayed

The MD has no more available space for recording or the MD has used up all its track numbers. Erase unnecessary tracks or record music on another MD.

■ The way track numbers are assigned varies depending on the source

When a CD or MD is played and recorded digitally by selecting [DIGITAL 1/2] with the [INPUT SELECTOR]:

- Track numbers on the recorded MD are assigned to match those on the source CD or MD. However, in the circumstances listed below only one track number may be assigned to a recorded section.
 - A section composed of the repeated playback of a single track on a disc (e.g. using single track repeat playback).
 - A section composed of the successive recording of tracks with the same track number from more than one disc. Also, if the source is an MD, track numbers may not be marked for tracks shorter than 3 seconds.

When the source is recorded with [ANALOG] or when a digital source other than a CD or MD is recorded with [DIGITAL 1] or [DIGITAL 2] while the Auto Track function is OFF:

- The entire recording may be counted as a single track with only one track number assigned to it.
 - Track numbers can be assigned manually at the desired points by pressing the [RECORD] button during recording.
 - Track numbers can be assigned automatically by switching the Auto Track function to "A_TRACK > ON" before starting recording.

Playback

Buttons used on this page

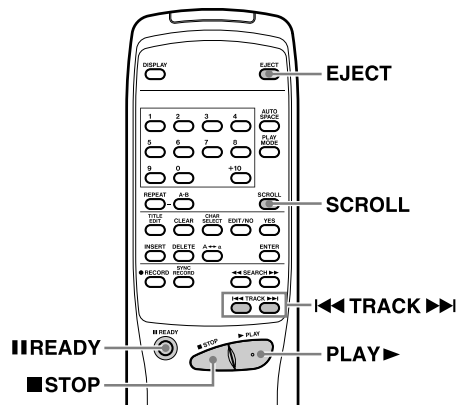
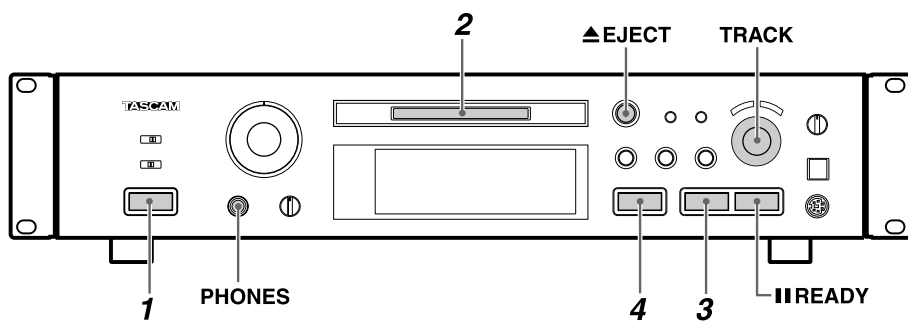

Normal Playback

1. Press the [POWER] button.
 - "NO DISC" appears on the display.
 - Turn on the amplifier and set the input selector to MD.

2. Insert an MD.

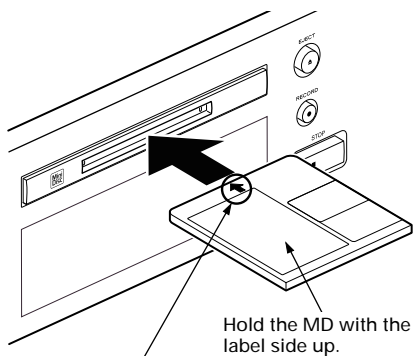

Insert in the direction of the arrow.

- After the TOC (Table Of Contents) data has been read, the disc title (when the disc has a title assigned to it), the total number of tracks and the total playing time of the disc are displayed.

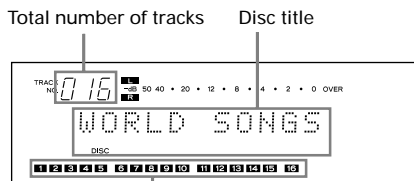

Music calendar

- The disc or track title can be scrolled on the display with the [SCROLL] button on the remote control unit. After scrolling, the title returns to its original display.

3. Start playback.

Press the [▶PLAY] button ("▶" lights up). Playback starts from the first track and "001" appears on the "TRACK NO." display.

 - When the disc finishes playback, the track numbers disappear from the music calendar.
 - If the total number of tracks exceeds 20 ("OVER" lights up), the track number should be confirmed on the TRACK NO. display.
 - Press the [▶PLAY] button immediately after recording is stopped (within 10 seconds) to play back a track which has just been recorded from the beginning.
 - If ten seconds or more have passed after recording is stopped, or if the [▶PLAY] button is pressed after pressing the [■STOP] button, playback starts from the first track of the disc.

4. To stop playback, press the [■STOP] button.

- **To stop playback temporarily (ready)**
Press the [||READY] button ("||" lights up).
 - Press the [▶PLAY] or [||READY] button to resume playback.

- **To play a track located before or after the current track**
Turn the [◀◀TRACK▶▶] dial.
 - If you are operating the remote control unit, select the desired track by pressing the [◀◀TRACK▶▶] buttons or entering the track number with the numeric buttons.
 - The selected track number starts playing.

- **To eject the MD**
Press the [▲EJECT] button.

- **Headphones**
When using headphones, connect the headphone plug into the PHONES jack.
 - Adjust the level of the signals output from the phones jack.

Condensation

When the deck is moved directly from a cold to a warm location or when the temperature is raised suddenly in the room where the deck is installed, moisture may condense inside the mechanism. This will prevent the deck from operating normally and may result in damage to the MD or to precision parts. If condensation occurs, turn on the deck and leave it for an hour or two until the moisture evaporates.

Useful Tips for Recording

Buttons used on this page

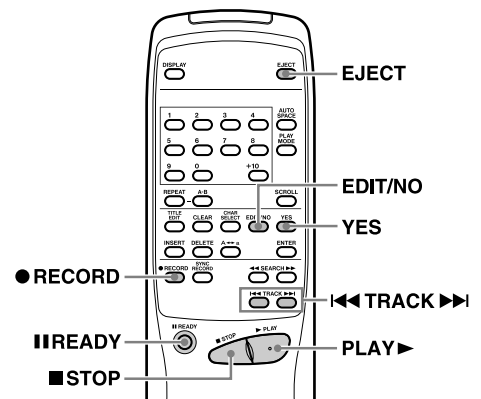
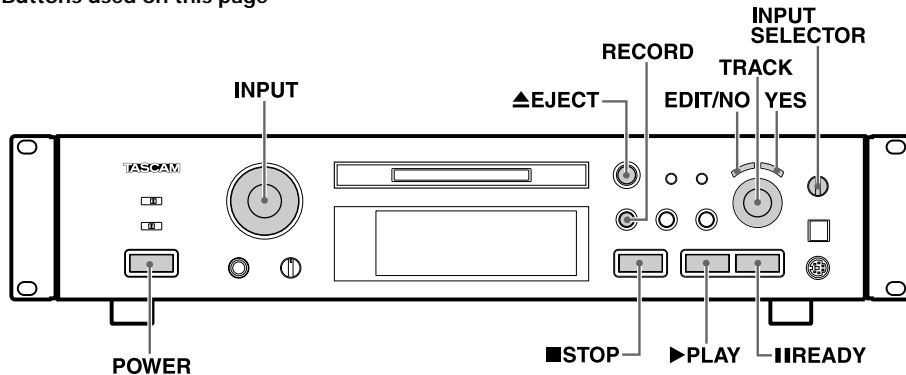

Monitoring the Input Signal

You can monitor the input signal of the component connected to each input terminal before recording.

1. Press the [▲EJECT] button to eject the disc.
 2. Select the input source with the [INPUT SELECTOR].
 3. Press the [●RECORD] button. ("Monitor Mode" appears.)
- Even when the [REC MODE] is set to [MONO], the output is sent to both channels.
 - Insert an MD or press the [■STOP] button to cancel the Monitor mode.

Adjusting the Recording Level

When recording with [ANALOG] selected with the [INPUT SELECTOR] and the signal input through the [ANALOG INPUT] jacks, adjust the recording level with the [INPUT] control.

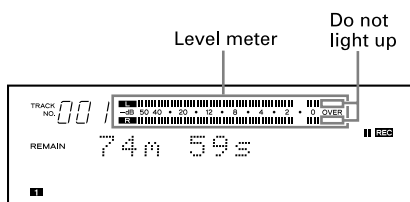

1. Insert a recordable MD and press the [●RECORD] button to enter the Record-Ready mode ("|| REC" lights up).
 2. Play the highest-level section of the program source and turn the [INPUT] control so that the "OVER" segments of the peak level meters do not light.
- Recording level adjustment is not necessary for digital recording.
3. Play the program source again.
- Press the [▶PLAY] or [||READY] button to start recording.

Assigning Track Numbers During Recording

Assigning track numbers at specific points will make it easy to quickly locate those points later using the playback or editing functions.

■ To assign track numbers automatically (Auto Track function)

Track numbers can be assigned automatically during recording by setting the Auto Track function to ON.

1. In the Record or Record-Ready mode, press the [EDIT/NO] button until "A_TRACK >" appears.
 2. Turn the [◀TRACK▶] dial to select "A_TRACK > ON".
 3. Press the [YES] button to end the setting function.
- While the Auto Track function is "ON", the signal level must remain low for 2 or more seconds before a new track number is advanced.
 - During digital recording from a CD or MD, the track numbers are advanced automatically according to the CD or MD data.
 - Once the Auto Track function is "ON", this mode will not be released even after the power is turned off. Press the [YES] button after selecting "A_TRACK > OFF" to release it.

■ To assign track numbers manually

Press the [●RECORD] button at every point where you want to assign a track number during recording. Each press of the button advances the track number.

■ To assign track numbers after recording

A track number is added when a track is divided in editing. (See "Dividing a track" on page 16.)

Note:

Changing the input or mode with the [INPUT SELECTOR] or [REC MODE] switch during recording activates the Record-Ready mode.

Recording Over Existing Tracks (Over Write)

The Over Write function allows you to record music by erasing a previously recorded track.

1. Perform steps 1 to 4 of "Recording an MD" on page 8.
 2. Turn the [◀TRACK▶] dial (or press the [◀TRACK▶] buttons on the remote control unit) until the track number to be recorded over appears.
 3. Press the [●RECORD] button ("|| REC" lights up).
- After "Over Write" appears, the remaining recording time is displayed.
 - The track numbers which come after the track being recorded over blink on the music calendar.
4. Adjust the recording level.
 - If [ANALOG] was selected above, adjust the recording level with the [INPUT] control.
 5. Press the [▶PLAY] button or [||READY] button to start recording.
- The deck records over the existing track. The track number is updated.

■ Recording over an existing track from the middle

1. Select the track number to be erased then press the [▶PLAY] button to start playback.
 2. Press the [||READY] button where you want to start recording.
 3. Press the [●RECORD] button.
- The track number is updated and blinks on the music calendar.
4. Press the [▶PLAY] or [||READY] button to start recording.
- The deck records over the existing track.

[CAUTION]

- It is not possible to record from the middle of an existing track when "SHUFFLE" or "PROGRAM" is lit.

Buttons used on this page

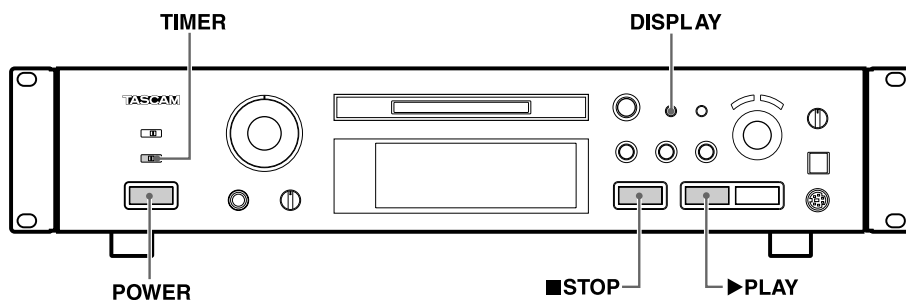
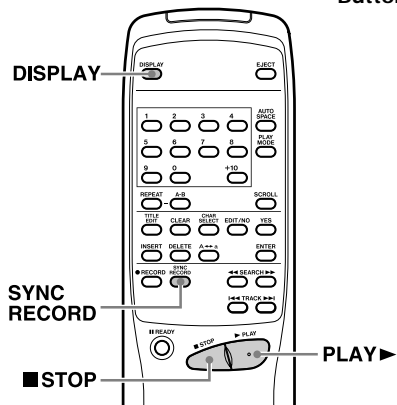

Sync Recording

The deck starts recording when the input audio exceeds a certain level and pauses when the input audio has dropped below a certain level continuously for 4 seconds or more.

1. Perform steps 1-6 of "Recording an MD" on page 8.
2. Press the [SYNC RECORD] button on the remote control unit. The deck enters the Sync Record-Ready mode. ("■ REC" and "■ SYNC" light up.)
 - The remaining recording time appears after "S_SYNC ON" is displayed.
3. Start playing the source component.
 - The deck starts sync recording upon detection of the input audio signal. It pauses when the input audio level drops below a certain level.
 - You cannot start recording manually by pressing the [▶ PLAY] button or [■ READY] button in the Sync Record-Ready mode.
 - Press the [SYNC RECORD] button again to cancel sync recording. After "S_SYNC OFF" is displayed, the remaining recording time appears.

Notes:

- Pressing the [■ READY] button during sync recording aborts the Sync Record operation.
- Changing the input or mode with the [INPUT SELECTOR] or [REC MODE] switch during sync recording aborts the Sync Record operation.

Checking the Remaining MD Recording Time

With each press of the [DISPLAY] button, the display changes as follows:

In the Stop /Record mode:

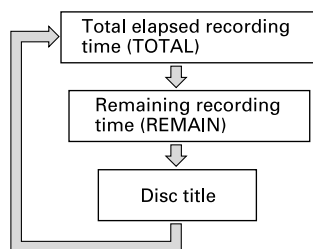

- The remaining recording time (REMAIN) is only displayed in the Record-Ready mode.
- The disc title can be displayed only when it has been recorded onto the MD.

Checking the Recorded Tracks

■ Press the [▶ PLAY] button immediately after stopping recording.

The track which has just been recorded will be played from the beginning.



■ To play from the first track of the MD after recording:

Press the [■ STOP] button again immediately after stopping recording then press the [▶ PLAY] button.

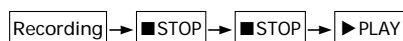

Timer Recording

By connecting this deck with a timer (commercially available), you can start and stop recording operations at a preset time.

1. Perform steps 1 to 6 of "Recording an MD" on page 8.
2. Set the [TIMER] switch to [REC].
3. Set the [TIMER] so that it starts and stops power supply at the desired start time and end time.
 - As the actual recording starts after the "TOC Reading" operation, set the timer recording start time to slightly before the time when you want to start recording.
 - Each component power is turned off.
 - When the start time comes, power is supplied to the components and recording starts.

[CAUTION]

- When timer recording is performed in the "SHUFFLE" mode or "PROGRAM" mode, the deck automatically enters the "CONTINUE" mode.
- Be sure to turn the deck on again and eject the MD within 3 or 4 days of timer recording. When the MD is ejected, the recorded contents will be written on the MD. If the deck is left off for a long time after the timer recording has finished, the contents may disappear.
- During timer recording, recording starts from the end of the previously-recorded portion on the MD.
- Set the [TIMER] switch to [OFF] after timer recording. If the timer is left in [REC], the deck will automatically start recording the next time the power is turned on.

Useful Tips for Playback

Buttons used on this page

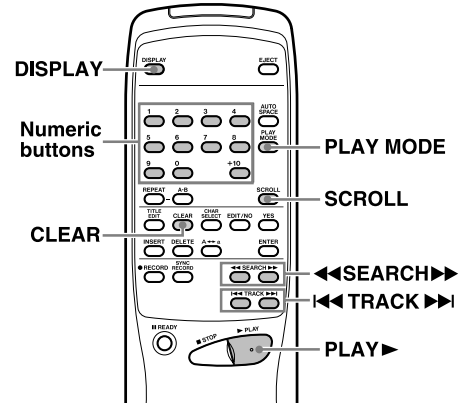
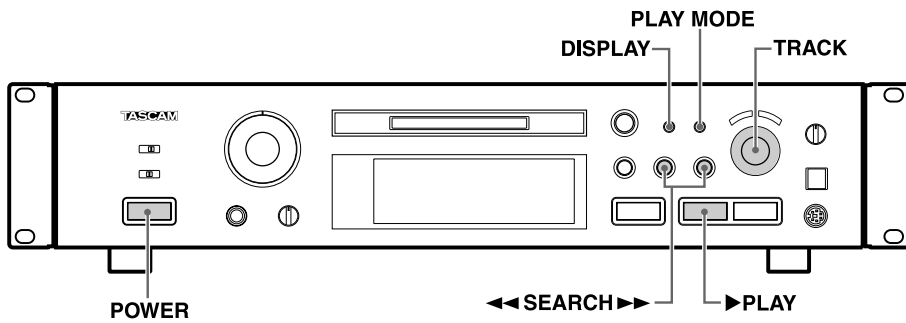

Using the Display Window

The information shown on the display allows you to check the disc title, track title, the total track number in an MD, total playing time, remaining recordable time of the MD.

- Each press of the [DISPLAY] button changes the display as shown below.

In the Stop mode:

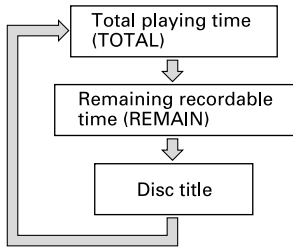

In the Play mode:

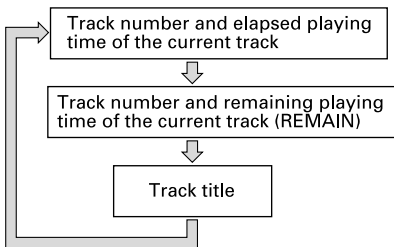

- The total number of tracks appears on the TRACK NO. display.
- The disc title and track titles are displayed only when they have been recorded onto the MD.
- When a track has been selected in the Stop mode ("TRACK" is lit), pressing the [DISPLAY] button displays the track title.
- When a track title is composed of more than 100 characters, the 100th character and beyond cannot be displayed.
- The disc or track title can be scrolled on the display with the [SCROLL] button on the remote control unit. After scrolling, the title returns to its original display.

Selecting the Desired Track

Playing a track by direct search

Specify the desired track by pressing the numeric buttons (1 to 9, 0, +10) on the remote control unit. The specified track starts to play.

- Examples of operation for direct search of track number 10 or more:
To search track number 10:
Press +10 once then 0.
To search track number 25:
Press +10 twice then 5.
- Press the [CLEAR] button while "TRACK NO." is blinking to cancel it.

To skip to the previous or next track

Turn the [TRACK] dial clockwise or counterclockwise (or press the [TRACK] buttons on the remote control unit) during playback to skip to a track located after or before the current track.

To search a desired section

During playback, press and hold the [SEARCH] (or [SEARCH]) buttons to search the desired section.

- In the Play-Ready mode, the desired section can be searched by observing the elapsed playing time or remaining playing time on the display.
- Normal search may not be possible if there are several successive short tracks of only a few seconds in length.

Playing Tracks in Random Order (Shuffle Playback)

Each track on the disc is played once in random order.

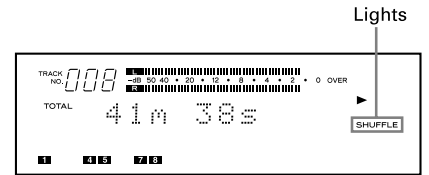

1. In the Stop mode, press the [PLAY MODE] button repeatedly until "SHUFFLE MODE" is displayed ("SHUFFLE" lights up).
2. Press the [PLAY] button.

- To play the next track, turn the [TRACK] dial clockwise (or press the [TRACK] button on the remote control unit) during shuffle playback.
- To play from the beginning of the current track, turn the [TRACK] dial counterclockwise (or press the [TRACK] button on the remote control unit) during shuffle playback.
- The Shuffle mode will not be canceled even when the power is turned off.
- To cancel the Shuffle mode, press the [PLAY MODE] button repeatedly until "CONTINUE MODE" is displayed.

Buttons used on this page

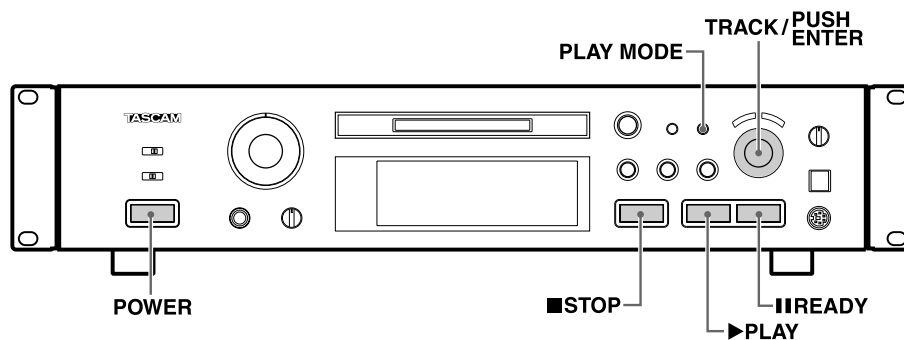
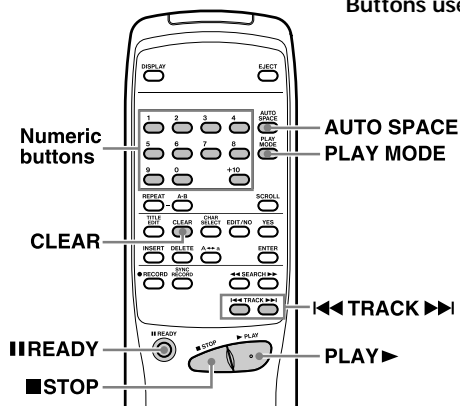

When Recording to Analog Tape

To play tracks with spaces inserted after every track (Auto Space playback)

The Auto Space playback function inserts a 3-second blank space between each track. This makes possible music scan operations when recording from MDs to analog tape.

1. Press the [AUTO SPACE] button on the remote control unit once so that "A_SPACE ON" is displayed. ("A_SPACE" lights up.)
2. Press the [▶PLAY] button.
 - To release Auto Space Playback, press the [AUTO SPACE] button repeatedly until "A_SPACE" disappears.

To pause after each track (Auto Ready playback)

The deck can enter the Ready mode after playing each track. This feature is convenient when copying a single MD track onto tape or when the tracks to be copied are not continuous.

1. Press the [AUTO SPACE] button on the remote control unit twice so that "A_READY ON" is displayed. ("A_READY" lights up.)
2. Press the [▶PLAY] button.
 - When playback is finished, the deck pauses at the beginning of the next track.
3. Press the [▶PLAY] or [||READY] button to start playing the next track.
 - To release Auto Ready playback, press the [AUTO SPACE] button repeatedly until "A_READY" disappears.
 - A_SPACE and A-READY playback cannot be used together.

Playing Tracks in the Desired Order (Program Playback)

Up to 25 tracks can be programmed in the desired order and played.

To program tracks

1. In the Stop mode, press the [PLAY MODE] button repeatedly until "PGM MODE" appears in the display. After "PGM MODE", the display shows "0m 00s 00p" ("PROGRAM" lights up).
2. Turn the [◀◀TRACK▶▶] dial so that the desired track number indicator lights on the music calendar, and press [PUSH ENTER] on the dial.
 - The track number blinks.
 - Repeat this operation to program other tracks.
 - Tracks can be programmed automatically by simply pressing the numeric buttons (1 to 9, 0, +10) on the remote control unit to display their numbers sequentially.
 - When a track number of 21 or more is selected, the "OVER" indicator blinks. However, the track number can still be checked on the TRACK NO. display.
 - The same track can be programmed repeatedly.
 - If you make a mistake in the track number entry, press the [CLEAR] button. Each press clears the current last track in the program.

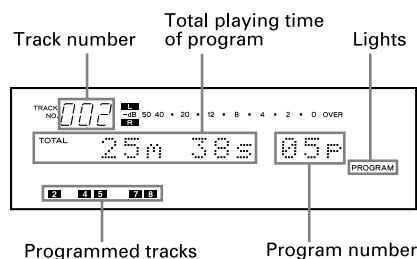

3. Press the [▶PLAY] button to start Program playback.

- The program is held in memory after Program playback has been stopped by pressing the [■STOP] button or it has stopped automatically at the end.
- Pressing the [■STOP] button in the Stop mode clears the program memory.
- When the total program playback time is longer than 159 minutes and 59 seconds, "---m--s" appears on the time counter.
- When the 25th track has been programmed, "PGM Full !!" is displayed and no more tracks can be programmed.
- Pressing the [PLAY MODE] button in the Stop mode cancels the Program Play mode and clears the program memory.
- The Program mode will not be canceled even when the power is turned off, and the programmed data will remain in the deck.
- If you attempt program playback when no programmed data is entered, normal playback will start after "PGM Empty !!" is displayed.

To check the program contents

In the Play or Play-Ready mode, turn the [◀◀TRACK▶▶] dial or press the [◀◀] or [▶▶] button on the remote control unit to display the program contents.

To delete a programmed track

In the Stop mode, press the [CLEAR] button. Each press clears the current last track in the program.

To add a track to the program

In the Stop mode, turn the [◀◀TRACK▶▶] dial to select the desired track number and press [PUSH ENTER] on the dial.

A track can also be added from the remote control unit by simply entering the track number with the numeric buttons (1 to 9, 0, +10).

- The new track is appended to the end of the existing program.

Useful Tips for Playback

Buttons used on this page

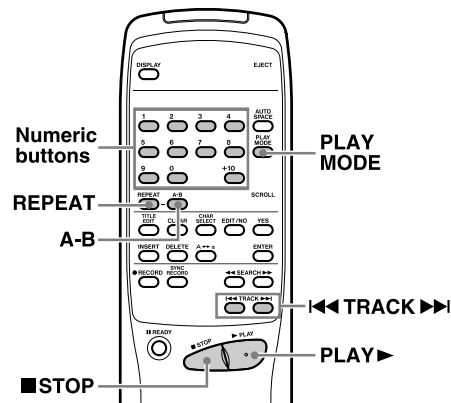
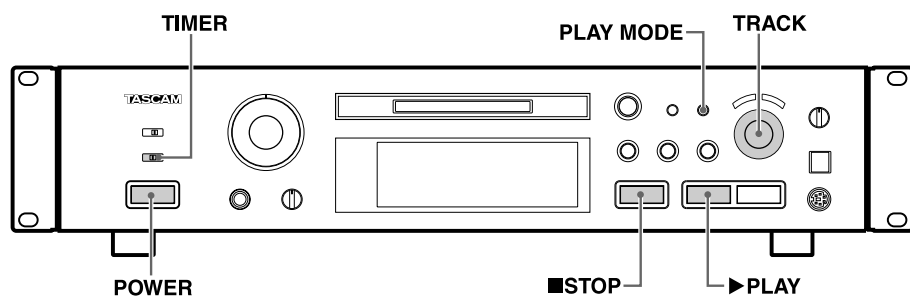

Repeating Track(s) (Repeat Playback)

All or one of the tracks, or a specified portion (A-B) of an MD can be played repeatedly. Program playback and Shuffle playback can also be repeated.

■ To repeat all MD tracks (All-track repeat)

1. In the Stop mode, press the [PLAY MODE] button to select one of the following repeat play modes.

Play Mode	Repeat
CONTINUE	Normal repeat
SHUFFLE MODE	Shuffle repeat
PGM MODE	Program repeat

2. Press the [REPEAT] button on the remote control unit once to display "REPEAT ALL".
 - "ALL REPEAT" lights up.
3. Press the [▶PLAY] button. The tracks will be played repeatedly in the specified mode.
 - To release REPEAT playback and resume normal playback, press the [REPEAT] button repeatedly until "REPEAT OFF" appears.
 - The Repeat Playback mode will not be canceled even when the power is turned off.

■ To repeat a single track (Single-track repeat)

1. During playback in the "CONTINUE MODE", press the [REPEAT] button on the remote control unit twice.
 - "REPEAT 1" appears ("REPEAT" and "SINGLE" light up).
2. Press the [▶PLAY] button. The current track will be repeated.
3. The track to be repeated can be changed by turning the [◀◀TRACK▶▶] dial or by pressing the [◀◀TRACK▶▶] buttons or numeric buttons (1 to 9, 0, +10) on the remote control unit.
 - Single-track repeat is unavailable in the "SHUFFLE MODE" or "PGM MODE".

■ To repeat a section within a track (A-B repeat)

- A specified portion (between A and B) of a track can be played repeatedly.
1. During playback, press the [A-B] button on the remote control ("REPEAT A-" is displayed, and "A-B" blinks) at the starting point (A) of the portion you want to repeat.
 2. Press the [A-B] button again ("REPEAT A-B" is displayed, and "REPEAT" and "A-B" light steadily) at the ending point (B). The portion (A-B) will be played repeatedly.
 - A-B repeat playback of portions extending over more than one track is not possible during programmed playback or shuffle playback.
 - To cancel Repeat playback and resume normal playback, press the [A-B] button or [REPEAT] button again. ("REPEAT OFF" is displayed.)
 - Press the [■STOP] button to erase the specified portion (between A-B).

Timer Playback

By connecting this deck with a timer (commercially available), playback can be started at a specified time.

1. Insert a pre-recorded MD and set the [TIMER] switch to [PLAY].
2. Select the amplifier's input which allows this deck to play back.
 - Timer playback is available when "SHUFFLE MODE", "PGM MODE", "ALL REPEAT" or "REPEAT SINGLE" playback is selected.
3. Set the timer to the desired start time and turn off the power. When the set time comes, each component will be turned on and playback will start.
 - Set the [TIMER] switch back to [OFF] after timer playback.

Editing Recorded MDs

Buttons used on this page

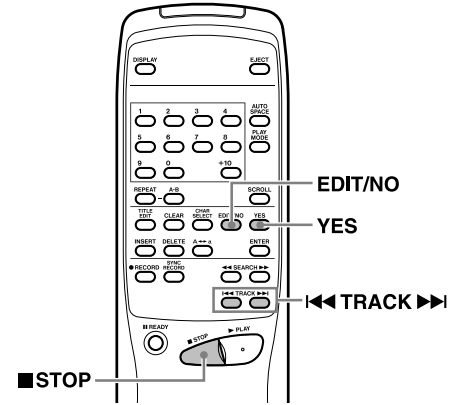
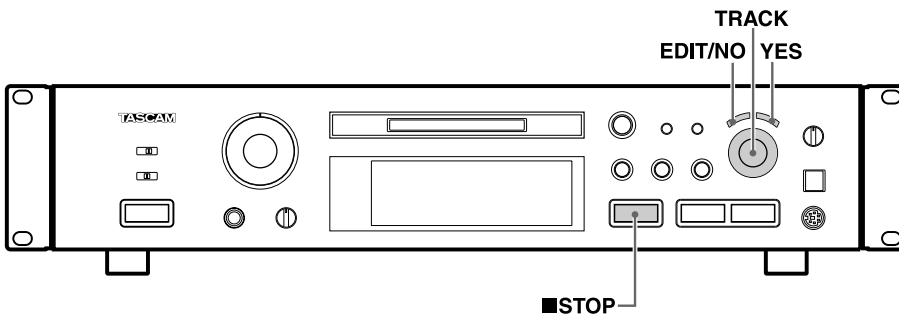

Notes on Editing

Available editing operations include erasing, moving, dividing and combining tracks. It is also possible to assign disc and track titles.

■ When "Protected !!" is displayed

The MD is record-protected against accidental erasure. To make recording or editing possible, slide the record-protect tab to close the hole.

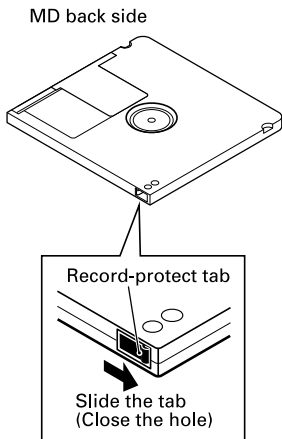

■ While "UTOC Writing" is blinking

This message indicates that the recorded data is being written on the MD. Do not pull out the power cord or vibrate the deck. Otherwise the recorded data may not be written correctly on the MD.

Erasing Track(s) (ERASE Function)

The data written on an MD can be erased in the following ways.

- Erasing all tracks simultaneously
- Erasing a single track
- Erasing parts of a track

■ To erase all tracks at once (DISC ERASE)

1. In the Stop mode, press the [EDIT/NO] button repeatedly until "ERASE DISC ?" is displayed.

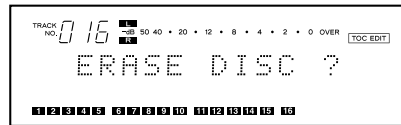

2. Press the [YES] button. ("Sure ?" is displayed.)
 - Pressing the [EDIT/NO] button or the [STOP] button while "Sure ?" is displayed aborts the operation.
3. Press the [YES] button again. "COMPLETE" is displayed and then "Blank Disc" is displayed to indicate that all recorded data on the MD has been erased.
- If "ERASE DISC ?" is selected with the [EDIT/NO] button while "Blank Disc" is displayed, and then the [YES] button is pressed, UNDO (which cancels the most recent operation) cannot be performed.

■ To erase a single track (TRACK ERASE)

(Example): To erase B in track number 2

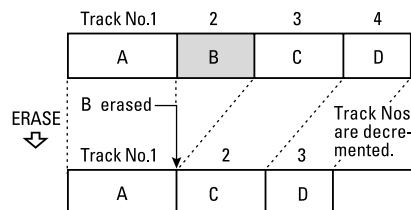

1. Specify the track to be erased with the [◀◀TRACK▶▶] dial.

2. Press the [EDIT/NO] button repeatedly until "ERASE TRK ?" is displayed.
3. Press the [YES] button. ("Track OK ?" is displayed.)
 - Pressing the [EDIT/NO] button or the [STOP] button while "Track OK ?" is displayed aborts the operation.
4. Press the [YES] button again. "COMPLETE" is displayed. Once the specified track has been erased, the subsequent track is decreased by one and all tracks following are renumbered.
- Repeat this procedure to erase additional tracks.

■ To erase a part of a track

This operation consists of dividing the track, erasing one of the tracks obtained by division and combining the remaining tracks. A part of a track can be erased using these three functions.

(Example): To erase a part of A with track number 1

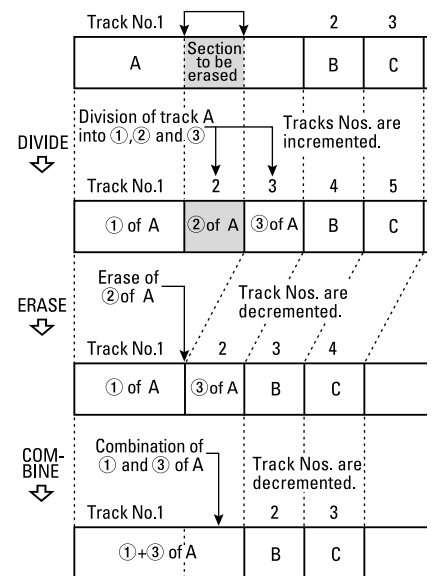

Dividing a Track (DIVIDE Function)

A recorded track can be divided into two tracks and a track number can be assigned to the second track. This function is designed for use when a single track contains several musical pieces (for example with an analog-recorded MD), or when you want to mark a point for use in track location.

(Example): To divide C and D contained in track number 3 into two tracks

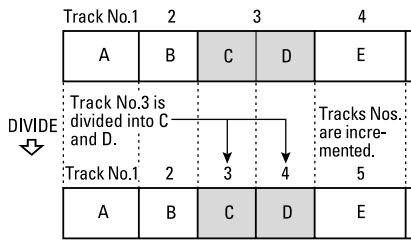

1. During playback, press the [REPEAT] button at the point where you want to divide the current track into two.
2. Press the [EDIT/NO] button repeatedly until "DIVIDE ?" is displayed.

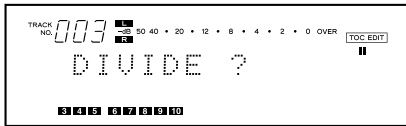

3. Press the [YES] button.
 - "Rehearsal" and "Point OK ?" are displayed alternately while the first 4 seconds of the portion which becomes the second track after division are played repeatedly.
4. If the original track is not divided as precisely as desired, you can fine-adjust the division point by turning the [TRACK] dial while monitoring the sound.
 - The division point can be adjusted within an offset range of -88 ~ +127 (±1 corresponds to approx. 0.06 sec.).
5. Press the [STOP] button or [EDIT/NO] button to abort the operation.
5. When the track is divided at the desired point, press the [YES] button again.
 - The track numbers of the new track (second track after division) and subsequent tracks are increased by one but these new numbers are still continuous.
 - "COMPLETE" is displayed and the track is divided. The deck will start to play the new track obtained after division.
 - Tracks obtained after division do not have track titles, regardless of whether the original track had one or not.
 - The beginnings of tracks cannot be divided.

Combining Tracks (COMBINE Function)

Two consecutive tracks can be combined into a single track. This function is designed for use when you want to play several songs continuously or you want to make a single track from many separately recorded parts of music.

(Example): Combining B and C

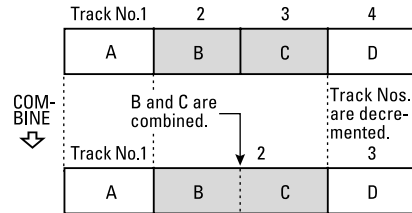

1. Select a track number by turning the [TRACK] dial.
 - The selected track number will be combined with the track before it. For example, to combine track numbers 2 and 3, select track number 3 in this step.
 - If you select track 1, it will not be combined into a single track.
2. Press the [EDIT/NO] button until "COMBINE ?" is displayed.

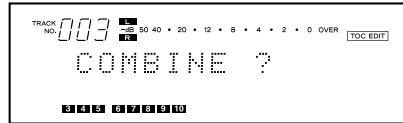

3. Press the [YES] button.
 - "Rehearsal" is displayed. The beginning of the selected track is played back repeatedly.
 - If the combination point between the two tracks is not played properly, press the [EDIT/NO] button to stop playback and restart the operation from the beginning.
 - Press the [STOP] button to abort the operation.
4. If the combination point is correct, press the [YES] button again.
 - "COMPLETE" is displayed for a few seconds and the tracks are combined.
 - When both tracks have titles assigned, the title of the track before the selected track is assigned to the combined track. Subsequent track numbers are decreased by one.

Moving a Track (MOVE Function)

The order of tracks can be changed by moving a track to another position. After the track has been moved, track numbers are automatically renumbered.

(Example): To move D from track number 4 to track number 2

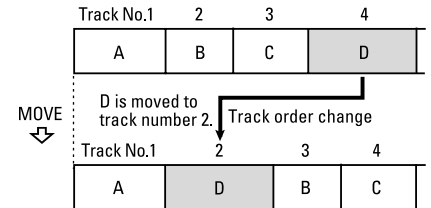

1. During playback, select the track to be moved by turning the [TRACK] dial.
2. Press the [EDIT/NO] button until "MOVE ?" is displayed.
3. Press the [YES] button.
 - "Move to 001?" is displayed. ("001" blinks.)

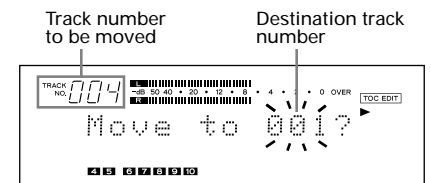

4. Select the destination track number with the [TRACK] dial.
 - "Move to 002 ?" is displayed. ("002" blinks.)
 - When you specify the destination track number with the numeric buttons, "COMPLETE" is displayed, then the track is moved and the track numbers are automatically changed. Playback resumes from the track's new location.
 - Press the [STOP] button or [EDIT/NO] button to abort the operation.

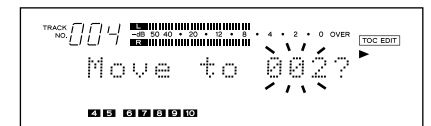

5. Press the [YES] button again.
 - "COMPLETE" is displayed, then the track is moved and the track numbers are automatically changed. Playback resumes from the track's new location.

Buttons used on this page

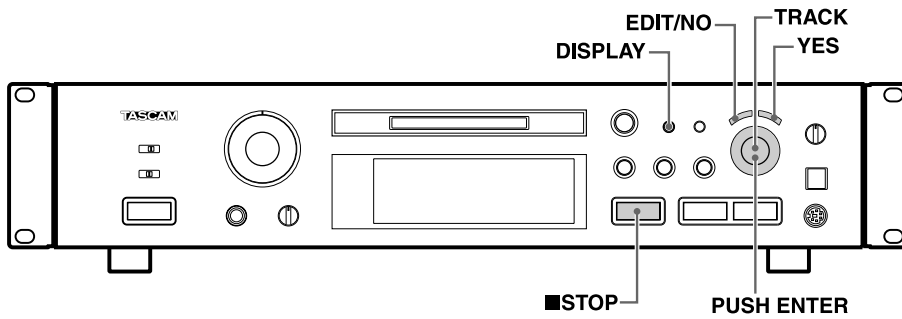

Assigning Titles (TITLE Function)

Titles can be assigned to each disc or each track using uppercase and lowercase letters, numbers, "カタカナ" (Katakana) and symbols.

1. Press the [EDIT/NO] button so that "TITLE ?" is displayed.
2. Press the [YES] button.
 - Press the [TITLE EDIT] button if you are using the remote control unit.
3. Select "DSC" or a track number using the [◀◀TRACK▶▶] dial.
- To assign a disc title, select "TITLE > DSC" ("DSC" blinks).

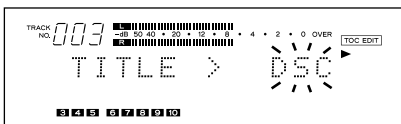

- To assign a track title, select "TITLE > XXX (track number)" (Track number blinks).

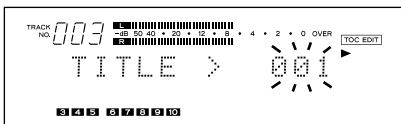

4. Press the [YES] button. "DSC > _" or "XXX > _" is displayed.
 - The character entry mode is engaged and the cursor blinks on the display.
5. Press the [DISPLAY] button to select the character type.
 - When "カタカナ" is lit: Katakana (square Japanese syllabary) can be entered.
 - When "CAPS" is lit: Capital alphabet letters, numerals and symbols can be entered.
 - When no indicator is lit: Small alphabet letters, numerals and symbols can be entered.
6. Select each character by turning the [◀◀TRACK▶▶] dial and pressing [PUSH ENTER] on the dial.

7. Repeat steps 5-6.
 - Press the [STOP] button to abort the operation.
 - Press the [EDIT/NO] button for more than 3 seconds (or press the [TITLE EDIT] button on the remote control unit) to cancel the title function and resume playback.
8. Press the [YES] button again.
 - The disc or track title is displayed again.
 - Repeat steps 1-8 to assign titles to other track numbers.

Assigning Titles to the Disc and All Tracks Successively (TITLE AUTO INC Function)

Select the "CONTINUE" mode with the [PLAY MODE] button. Titles can be assigned to the disc and all tracks successively.

1. Press the [EDIT/NO] button so that "TITLE ?" is displayed.
2. Press the [YES] button.
 - Press the [TITLE EDIT] button if you are using the remote control unit.
3. Select "TITLE > AINC" with the [◀◀TRACK▶▶] dial ("AINC" blinks).

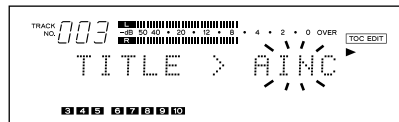

4. Press the [YES] button.
 - The disc title entry mode is engaged ("DSC > _" is displayed) and the cursor blinks on the display.
 - The cursor blinks at the first character position even if a title has already been assigned.

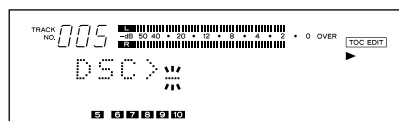

5. Press the [DISPLAY] button to select the character type.

6. Select each character by turning the [◀◀TRACK▶▶] dial and pressing [PUSH ENTER] on the dial.
 - If you are using the remote control unit, select each character with the [◀◀ TRACK▶▶] buttons and press the [ENTER] button to enter it.
7. Repeat steps 5-6.
8. Press the [YES] button after assigning the disc title.
 - The title entry mode for track 1 is automatically engaged ("001 > _" is displayed) and the cursor blinks on the display.

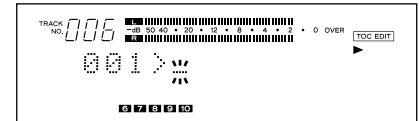

9. Repeat steps 5-6.
10. Press the [YES] button again.
 - When the title entry mode for track 2 is engaged ("002 > _" is displayed), repeat steps 5-8.
 - Repeat the character entry procedure until all titles have been entered. The disc title is then displayed if the deck is in the Stop mode, or if the deck is in the Play mode, the current track title is displayed.
 - Confirm titles by turning the [◀◀TRACK▶▶] dial.
 - Press the [STOP] button to abort the operation. Press the [EDIT/NO] button for more than 3 seconds (or press the [TITLE EDIT] button on the remote control unit) to cancel the title function and resume playback.

Notes:

- Up to 100 characters can be entered per track title. However, when the total number of characters of all track titles exceeds 1700, no more track titles can be written onto the MD.
- If the TITLE AUTO INC function is canceled before all titles have been assigned, the track title currently being entered will be erased. Only track titles which have already been assigned will be kept.
- If UNDO is performed after TITLE AUTO INC is completed, the last edited track title will be canceled.
- Disc and track titles can be assigned during recording.
- If a track title is assigned while in the Record-Ready mode during the overwriting of a track, the track title will be erased when you resume recording.
- "DISC" lights while a disc title is being entered, and "TRACK" lights while a track title is being entered.
- Assigning titles is unavailable in the "SHUFFLE MODE" or "PGM MODE".

Editing Recorded MDs

Buttons used on this page

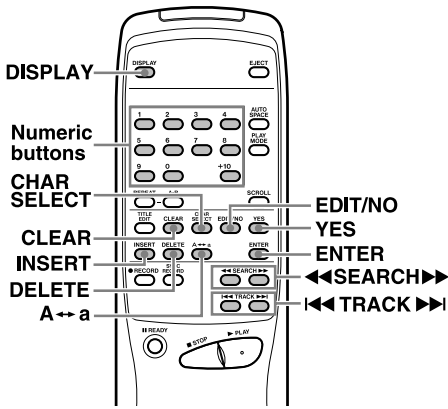

Character types selectable

- When "カタカナ" is lit: Katakana (square Japanese syllabary) can be entered.
- When "CAPS" is lit: Capital alphabet letters, numerals and symbols can be entered: A B C D E F G H I J K L M N O P Q R S T U V W X Y Z 0 1 2 3 4 5 6 7 8 9 ; < = > ? @ ! " # \$ % & ' () * + , - . / _ (space)
- When no indicator is lit: Small alphabet letters, numerals and symbols can be entered: a b c d e f g h i j k l m n o p q r s t u v w x y z 0 1 2 3 4 5 6 7 8 9 ; < = > ? @ ! " # \$ % & ' () * + , - . / _ (space)

Changing entered characters

Move the cursor to the character to be corrected in the character entry mode.

- Select a new character to change the character at the cursor position.

To move the cursor

Deck → Press the [SEARCH] buttons.
Remote Control Unit → Press the [SEARCH] buttons.

To select a character at the cursor position

Deck → Turn the [TRACK] dial.
Remote Control Unit → Press the [TRACK] buttons.

To change the character type at the cursor position

Deck → Press the [DISPLAY] button.
Remote Control Unit → Press either the [DISPLAY] button or [CHAR SELECT] button.

To change the character at the cursor position to an upper/lower case letter

Deck → Press the [DISPLAY] button.
Remote Control Unit → Press the [A ↔ a] button.

To insert a space at the cursor position

Deck → Press [PUSH ENTER] on the dial for 3 seconds or more.
Remote Control Unit → Press the [INSERT] or [ENTER] button for more than 3 seconds.

To enter a number

Deck → Turn the [TRACK] dial.
Remote Control Unit → Press the numeric buttons.

To erase a character at the cursor position

Deck → Press the [EDIT/NO] button.
Remote Control Unit → Press either the [DELETE] button or [EDIT/NO] button.

To move the cursor to the right after selecting a character

Deck → Press [PUSH ENTER] on the dial.
Remote Control Unit → Press the [ENTER] button.

To erase all the characters at once

Deck → Unavailable.
Remote Control Unit → Press the [CLEAR] button.

Copying a Title (TITLE COPY Function)

- In the Stop mode, display the disc title or track title (number) that you want to copy with the [TRACK] dial.

(Example): To copy the track 4 title

- Press the [EDIT/NO] button repeatedly until "TITLE COPY ?" appears.
- Press the [YES] button.
"Copy to 001 ?" is displayed.
("001" blinks)

(Example): To copy the track 4 title to track 6

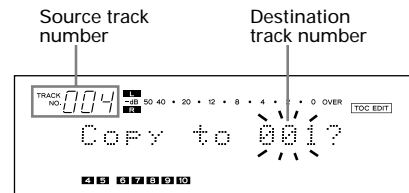

- Select the track to copy the title to with the [TRACK] dial.
"Copy to 006 ?" is displayed ("006" blinks).

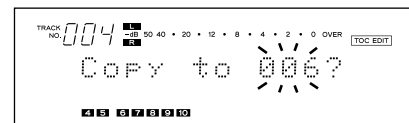

- Press the [STOP] button or [EDIT/NO] button to cancel the TITLE COPY mode.
- Press the [YES] button.
 - The title is copied to track number 006.
 - Pressing the [PLAY] button or [READY] button releases the title copy operation.

Canceling the Last Operation (UNDO Function)

- In the Stop mode, press the [EDIT/NO] button repeatedly until "UNDO ?" appears.

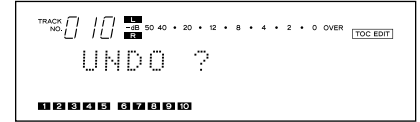

- Press the [YES] button.
"Sure ?" is displayed ("Sure" blinks).
- To cancel this function, press the [STOP] button or [EDIT/NO] button.
- Press the [YES] button.
- The last operation is undone and "COMPLETE" is displayed.
- Pressing the [PLAY] button or [READY] button releases the UNDO mode.

Notes:

- "UNDO ?" will not be displayed in the cases below, even if you press the [EDIT/NO] button (cannot undo).
- When the operation has already been undone (cannot undo an undo), or no operation has been performed to undo.
- When the editing mode is released by pressing the [YES] button.
- During recording or when the Recording-Ready mode is engaged.
- When "DISC ERASE" is performed on a blank disc.
- When the power is cut off.

Optional Functions

If you connect an IBM-compatible personal computer keyboard (101 or 106 keys) to the KEYBOARD terminal of this deck, you can operate the deck control, track selection, editing and title entry directly from the keyboard.

- Place the provided lettering guide around the keyboard function keys for your reference.

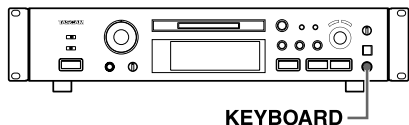

■ Correspondence between deck buttons and keyboard keys

Deck Buttons	Keyboard Keys
[◀◀]	F1 key
[▶▶]	F2 key
STOP button	F4 key
PLAY button	F5 key
READY button	F6 key
RECORD button	F8 key
AUTO SPACE button	F9 key
REPEAT button	F10 key
PLAY MODE button	F11 key
DISPLAY button	F12 key
YES button	Enter key
+10 button	+ key
Numeric buttons	Numeric keys
CLEAR button	Shift + F10 keys
EJECT button	Shift + F12 keys
◀◀	← key
▶▶	→ key

■ Editing keys

Function	Key Operation
ERASE TRACK	Shift + F1 keys
ERASE DISC	Shift + F2 keys
MOVE	Shift + F4 keys
DIVIDE	Shift + F5 keys
COMBINE	Shift + F6 keys
TITLE COPY	Shift + F7 keys
TITLE	Shift + F8 keys
UNDO	Shift + F9 keys
Mode cancellation	Esc key

■ Title entry keys

Operation	Key Operation
Move cursor	← key, → key
Change track number to be edited	↑ key, ↓ key
Switch uppercase/lowercase	Caps key
Erase character before cursor	BS (Back Space) key
Erase character on cursor	DEL (Delete) key
Insert character	INS (Insert) key
End title entry	Esc key

- Characters can be entered directly from the keyboard.
- When the track number to be edited is changed using [↑] or [↓], the track title will remain the same.
- "CAPS" and "カタカナ" cannot be used at the same time.
- When using a keyboard, do not turn the power on and off rapidly, as this may sometimes cause the keyboard to become unoperational.

System Restrictions

Because of the different recording systems used by Compact Cassette, DAT, etc., the MD (Mini Disc) is subjected to some system restrictions. These restrictions may result in the following problems. These are normal and are not malfunctions.

- **"Track Full" is displayed before the available recording time (max. 60 or 74 minutes) expires.**

"Track Full" is displayed whenever the number of allowable tracks is reached, regardless of the recording time still available. With the MD system, it is not possible to record more than 254 tracks. If you want to record more tracks, erase unnecessary tracks, record them on another MD, or use the editing procedure to combine existing tracks.

- **"Track Full" is displayed even though both the number of tracks and the recording time have not been filled.**

Whenever emphasis data or other signal enhancements are switched on-off in the middle of tracks, the track is separated at that point and "Track Full" may be displayed regardless of the recording time and number of tracks.

- **The remaining recording time of an MD does not increase although you have erased several tracks.**

The remaining recording time display ignores tracks shorter than 12 seconds. Therefore, the time may not increase if you have erased several short tracks.

- **The total elapsed recording time and remaining recording time does not coincide with the available recording time (max. 60 or 74 minutes).**

The minimum unit for recording data is usually 6 clusters (approx. 12 seconds). Data of less than 12 seconds still uses the 12-second space, so actual available recording time becomes shorter than rated. Also, if the MD is scratched, the scratched sections are automatically deleted and the time available is decreased accordingly.

Display Messages

The following messages are displayed depending on the operation conditions.

Message	Description
Blank Disc	The recordable MD contains no recorded data.
Cannot Copy !	Copying is not possible.
Cannot EDIT !	Editing is not possible.
Disc Error !	The data in the MD is abnormal.
Disc Full !!	No more recording is possible.
D-IN UNLOCK !	Digital input connection is not made.
ERASE DISC ?	Is it OK to erase the recorded data on the MD ?
ERASE TRK ?	Is it OK to erase this track ?
Name Full !!	The title memory is full.
NO DISC !!	No MD is inserted.
No Track !!	No track has been recorded.
PGM Empty !!	Tracks have not been programmed.
PGM Full !!	No more tracks can be programmed.
Play Mode !!	The selected play mode is inappropriate.
Protected !!	The MD is protected against accidental erasure. A playback-only MD is loaded.
Rec Error !!	A recording error occurred.
Track Full !!	The MD has used up all its track numbers.
UNDO ?	Is it OK to cancel the last operation ?
UTOOC Writing	The recorded data is being written on the MD.

- **Track combination may not be possible.**
Tracks created by other editing operations sometimes cannot be combined.
- **Audio is interrupted during search.**
When a track created by an editing operation is searched, audio is sometimes interrupted.
- **Track numbers are not assigned correctly.**
When a CD is recorded through a digital connection, short tracks may be recorded depending on the contents of the CD. Also, when auto track marking is performed, the track numbers may not be assigned correctly in some cases.
- **The "TOC Reading" display will not disappear.**
"TOC Reading" is displayed for a longer time than usual when a brand-new recordable MD is inserted.
- **Note the following when you attempt to perform recording while erasing (overwriting) the previous recording:**
 - The remaining recording time of the MD may not be displayed correctly.
 - After repeated overwrite operations, it may no longer be possible to overwrite recording. In this case, first edit the previous recording (by erasing tracks, etc.) then proceed to the overwrite operation.
 - The remaining recording time is shorter after recording than it was before recording.
 - The overwrite operation is not recommended if the track to be overwritten contains noise. Since recording is performed on a 6-cluster basis (approx. 12 seconds), overwriting a noisy track may erase a part of the track.
- **It is not possible to assign a track title during overwrite recording.**
- **Sometimes the maximum recording time (60 or 74 minutes) will not be available even after performing "ERASE DISC".**
In this case, try performing "ERASE DISC" again. However, you will not be able to UNDO it afterwards.

Guide to the Serial Copy Management System

Serial Copy Management System

This MD deck is in compliance with the Serial Copy Management System standard. This standard has been elaborated to restrict digital-to-digital copying to only the first generation. The basic rules governing this system are as described in the following.

• Rule 1

A digital recording is possible from a digital source such as a CD, DAT or pre-mastered MD onto a DAT or recordable MD through a digital input connection. However, further digital-to-digital recording is prohibited for the second generation and later.

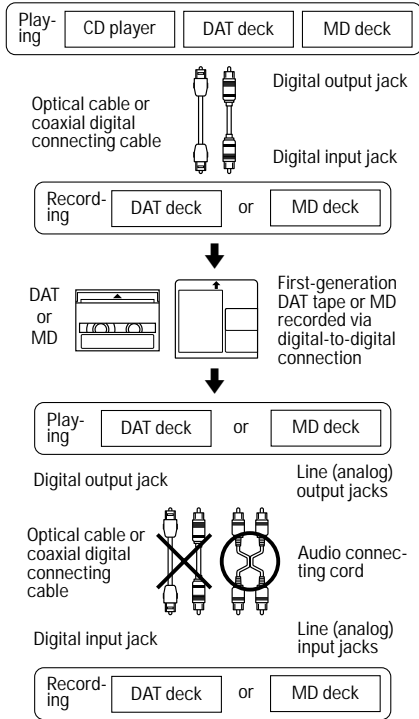

• Rule 2

When an analog source such as an analog disc or FM broadcast is digitally recorded by using a DAT or MD, this recorded source can be digitally recorded on another DAT or MD. However, further digital copying is prohibited.

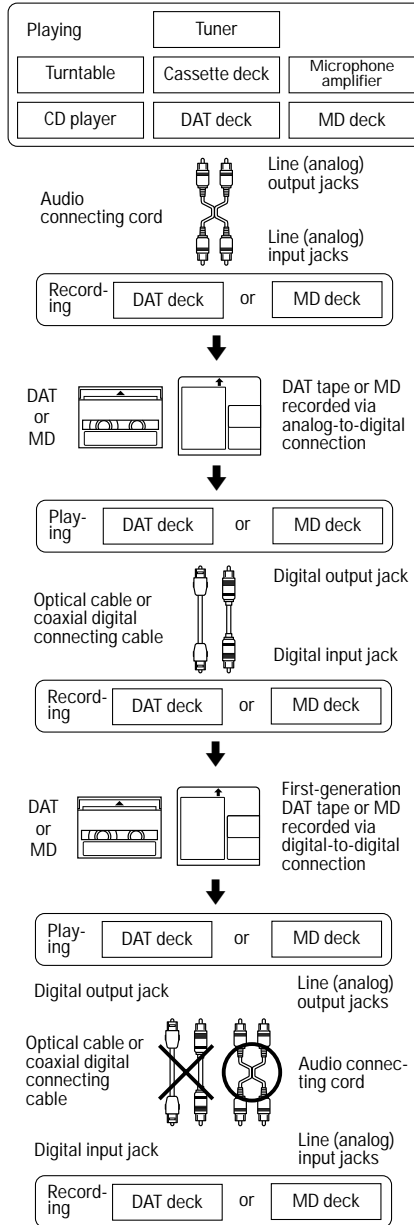

• Rule 3

A DAT deck or an MD deck which is compatible with 32 kHz and 48 kHz sampling frequencies can record the digital audio of satellite broadcasting digitally (digital-to-digital). A first-generation DAT or MD recorded in this way can be recorded again on another DAT or MD digitally (digital-to-digital). However, the second-generation DAT or MD may not be recordable with certain BS tuner models.

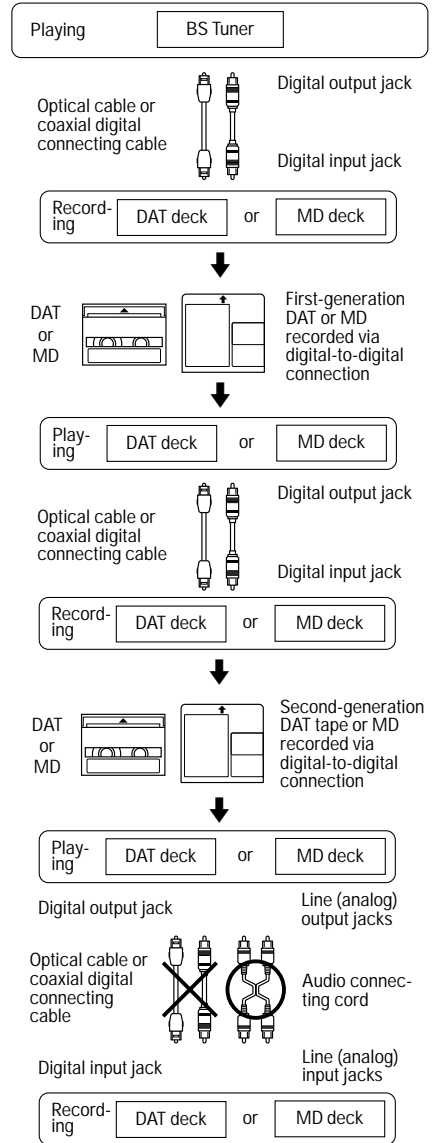

Troubleshooting

If you have any problems with the deck, please check the following before calling for service. If the trouble persists, please consult your dealer or nearest TEAC service agent.

Problem	Remedy
No operations are possible.	The MD is dirty or damaged. If "Disc Error !" is displayed in this case, replace the MD with another disc.
Playback will not start.	Check if power is supplied.
	"Blank Disc" is displayed if the MD contains no recorded data. "No Track !!" is displayed if no tracks have been recorded on the disc. Replace the MD with a pre-recorded MD.
	When "U-TOC Error !" is displayed, replace the MD with another disc.
Recording will not start.	There may be condensation inside the deck. In this case, eject the MD and leave the deck on for a few hours.
	When "Protected !!" is displayed, the MD is protected against accidental erasure. Slide the accidental erasure protection tab to close the hole. A playback-only MD is loaded. Replace the MD with a recordable one.
	When "D-IN UNLOCK !" is displayed and the source audio is not input, connect the source through digital connection or record the audio using the analog input.
	Timer recording is unavailable. After timer recording, turn the power back on within 3 or 4 days and eject the MD. If the deck is left off for a long time, the recorded contents may disappear.
	When "Disc Full !!" is displayed, the disc has no remaining time available for recording. Erase unnecessary tracks or use another MD.
When "Rec Error !!" is displayed, there is an error in recording. Restart recording from the beginning.	
Too much noise.	Do not operate this deck near a TV.

- If normal operation cannot be recovered, unplug the power cord from the outlet and plug it again.

■ U-TOC

Editing recorded tracks is easy with recordable MiniDiscs. Information about the recorded tracks (start address, end address, title, etc.) is recorded in the U-TOC (User Table Of Contents) area. You can edit tracks simply by rewriting this data.

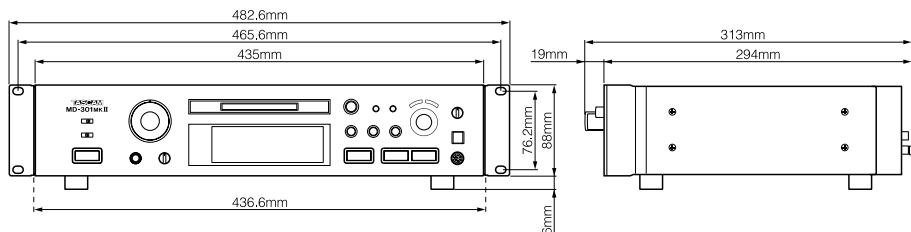
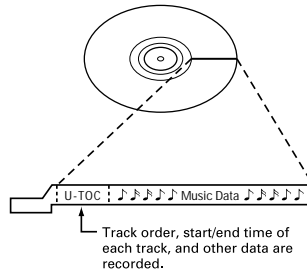

Specifications

- Format:** MiniDisc digital audio system
- Recording system:** Magnetic field modulation overwrite system
- Recording/playback time:** Stereo: 74 minutes max. Mono: 148 minutes max.
- Sampling frequency:** 44.1 kHz
- Compression system:** ATRAC (Adaptive Transform Acoustic Coding)
- Dynamic range:** More than 94 dB (playback, 1 kHz, A filter)
- Total harmonic distortion:** Less than 0.013%
- Number of channels:** 2 (stereo), 1 (mono)
- Frequency response:** 20 Hz – 20 kHz ± 0.5 dB (playback)
- Signal-to-noise ratio:** More than 94 dB (playback, A filter)
- Analog input/output connectors:**
 - Input:
 - Balanced: XLR, +4 dBu (ref.), 10 kohms
 - Unbalanced: RCA, -10 dBV (ref.), 50 kohms
 - Output:
 - Balanced: XLR, +4 dBu (ref.), 150 ohms
 - Unbalanced: RCA, -10 dBV (ref.), 600 ohms
- Power supply:**
 - 120 V AC, 60 Hz (U.S.A./Canada model),
 - 230 V AC, 50 Hz (Europe/General export model),
 - 240 V AC, 50 Hz (Australia model)
- Headphones output:** Max. 25 mW + 25 mW, 32 ohms
- Digital input/output connectors:**
 - Input 1, 2: TOS (EIAJ RC-5720), IEC60958 Type II (S/PDIF)
 - Output: TOS (EIAJ RC-5720), IEC60958 Type II (S/PDIF)
- Remote connector:** KEYBOARD connector: Mini DIN 6pin
- Power consumption:** 13 W
- Dimensions (W x H x D):** 482.6 x 94 x 313 (mm)
- Weight:** 5.5 kg
- Accessories:**
 - Remote control unit (RC-32) x 1
 - Battery (SUM-3, "AA", "R6" type) x 2
 - Lettering guide x 1
 - Rack mounting screw kit x 1

- Improvements may result in specifications or feature changes without notice.
- Photos and illustrations may differ slightly from production models.

* US and foreign patents licensed from Dolby Laboratories Licensing Corporation.

For U.S.A.

TO THE USER

This equipment has been tested and found to comply with the limits for a Class A digital device, pursuant to Part 15 of the FCC Rules. These limits are designed to provide reasonable protection against harmful interference when the equipment is operated in a commercial environment. This equipment generates, uses, and can radiate radio frequency energy and, if not installed and used in accordance with the instruction manual, may cause harmful interference to radio communications.

Operation of this equipment in a residential area is likely to cause harmful interference in which case the user will be required to correct the interference at his own expense.

CAUTION:

Changes or modifications to this equipment not expressly approved by TEAC CORPORATION for compliance could void the user's authority to operate this equipment

For CANADA

AC POWER CORD CONNECTION

CAUTION:

TO PREVENT ELECTRIC SHOCK, MATCH WIDE BLADE OF PLUG TO WIDE SLOT, FULLY INSERT.

CORDE DE CONNEXION CA

ATTENTION:

POUR ÉVITER LES CHOCS ÉLECTRIQUES, INTRODUIRE LA LAME LA PLUS LARGE DE LA FICHE DANS LA BORNE CORRESPONDANTE DE LA PRISE ET POUSSER JUSQU'AU FOND.

TEAC CORPORATION

3-7-3, Nakacho, Musashino-shi, Tokyo 180-8550, Japan Phone: (0422) 52-5082

TEAC AMERICA, INC.

7733 Telegraph Road, Montebello, California 90640 Phone: (213) 726-0303

TEAC CANADA LTD.

5939 Wallace Street, Mississauga, Ontario L4Z 1Z8, Canada Phone: 905-890-8008 Facsimile: 905-890-9888

TEAC MEXICO, S.A. De C.V

Privada De Corina, No.18, Colonia Del Carmen Coyoacan, Mexico DF 04100 Phone: 5-658-1943

TEAC UK LIMITED

5 Marlin House, Marlins Meadow, The Croxley Centre, Watford, Herts. WD1 8YA, U.K. Phone: 01923-819699

TEAC DEUTSCHLAND GmbH

Bahnstrasse 12, 65205 Wiesbaden-Erbenheim, Germany Phone: 0611-71580

TEAC FRANCE S. A.

17 Rue Alexis-de-Tocqueville, CE 005 92182 Antony Cedex, France Phone: 01.42.37.01.02

TEAC BELGIUM NV/SA

P.A. TEAC Nederland BV, Perkinsbaan 11a, 3439 ND Nieuwegein, Netherlands Phone: 0031-30-6048115

TEAC NEDERLAND BV

Perkinsbaan 11a, 3439 ND Nieuwegein, Netherlands Phone: 030-6030229

TEAC AUSTRALIA PTY., LTD.
A.C.N. 005 408 462

106 Bay Street, Port Melbourne, Victoria 3207, Australia Phone: (03) 9644-2442

TEAC ITALIANA S.p.A.

Via C. Cantù 11, 20092 Cinisello Balsamo, Milano, Italy Phone: 02-66010500
